

LED PROFILE SMART10 AC2/Z 2000 ANOD.







Surface



Furniture

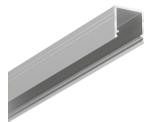

max 10 mm

	<ul style="list-style-type: none"> • continuous line of light (when using LED strip 120 P/m and opal diffuser) • Slick socket • miniature dimensions • universal application • the possibility of using waterproof LED strips 	 CE  EU industrial designs  Made in Poland	 <p>Buy product</p>
---	--	---	---

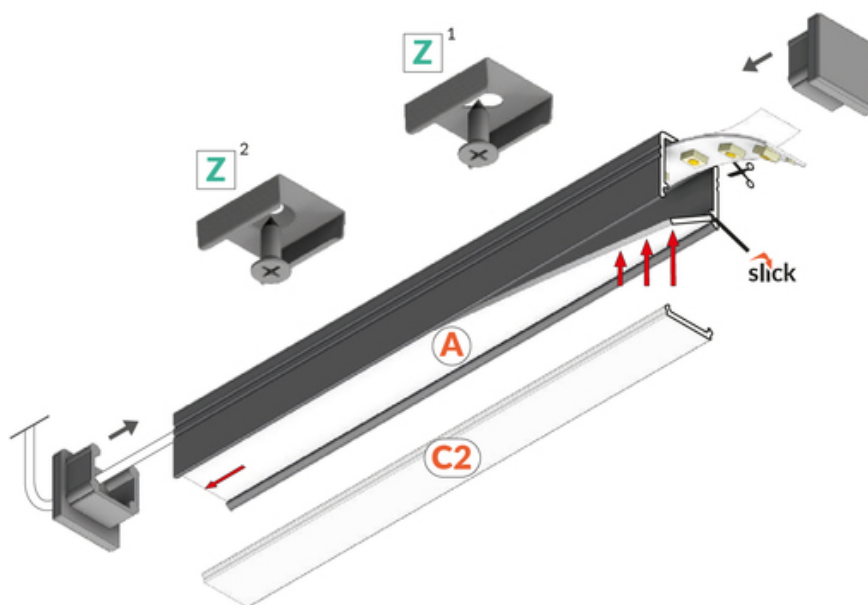
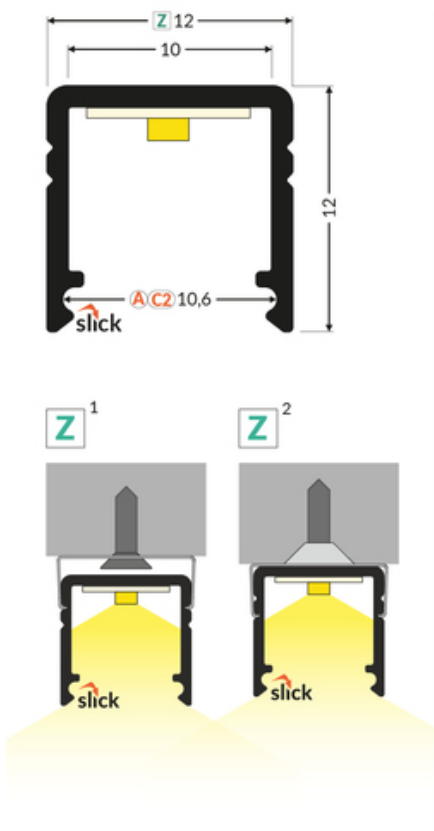

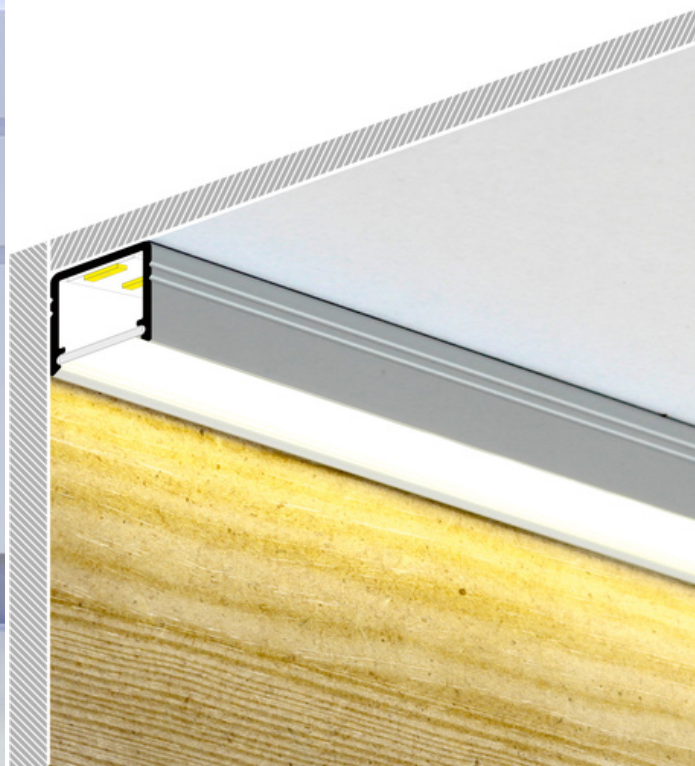

Basic Informations

<p>EAN: 5901597206125 Index: C2020020 Material: aluminium Color: anodized Length [mm]: 2000 Weight [kg]: 0.182 Net weight [kg]: 0.012 Country of origin: PL</p>	<p>Measurement unit: qty Product packaging dimensions [mm]: 2000 x 12 x 12 Bulk packing [qty]: 40 Master packaging type: Bulk Product with gross packaging weight [kg]: 7.28</p>
---	--

AVAILABLE COLORS

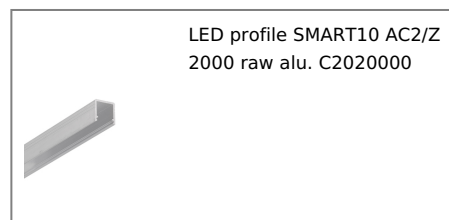
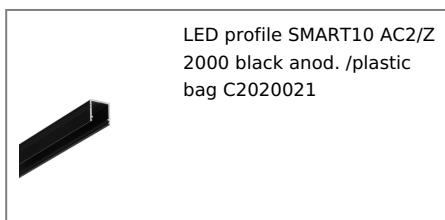

AVAILABLE VARIANTS

1000 mm, 2000 mm, 3000 mm, 4050 mm

Matching elements

DIFFUSERS

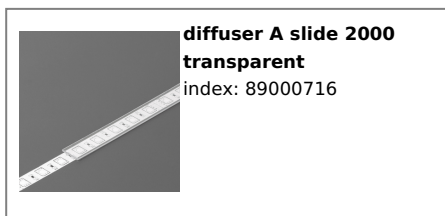
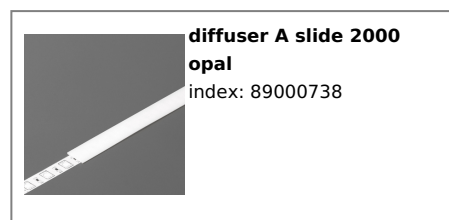
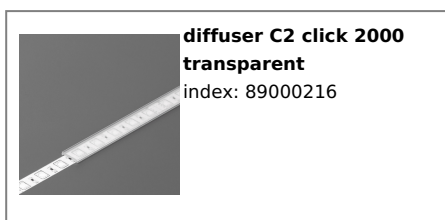
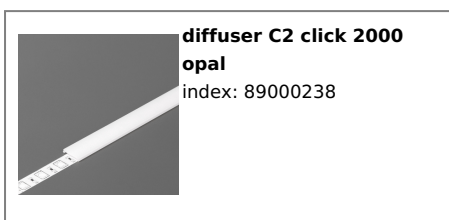

MOUNTINGS



**mounting plate Z inox
[500pcs]**
index: 89270019W



**mounting plate Z cone
inox [500pcs]**
index: 89980019W

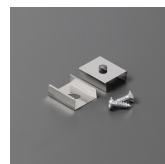

**mounting plate Z inox
[20pcs]**
index: 89270019



**mounting plate Z cone
inox [20pcs]**
index: 89980019

END CAPS



**end cap SMART10 grey
[20pcs]**
index: C2940022



**end cap SMART10 silver
[20pcs]**
index: C2940040



**end cap SMART10 with
hole grey [20pcs]**
index: C2960022



**end cap SMART10 with
hole silver [20pcs]**
index: C2960040

CONNECTORS



**connector SMART10
90deg anod. /plastic bag**
index: C2910020