

LED PROFILE SMART10 AC2/Z 2000 BLACK ANOD. [40PCS]

x40
pcs.

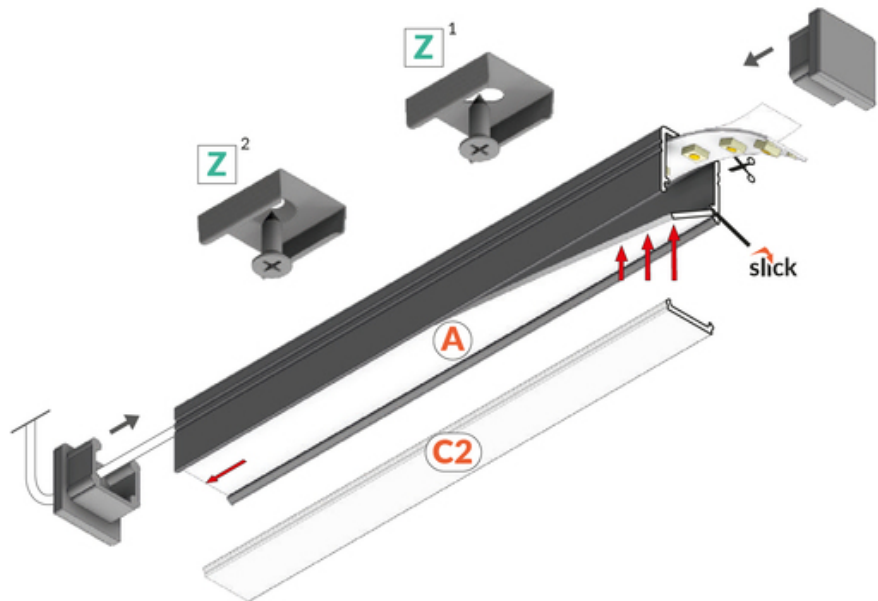

Buy product

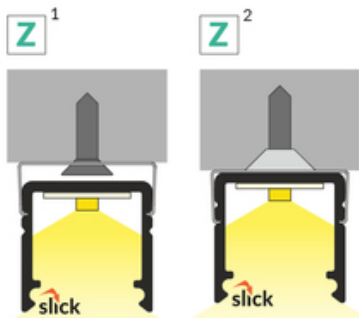
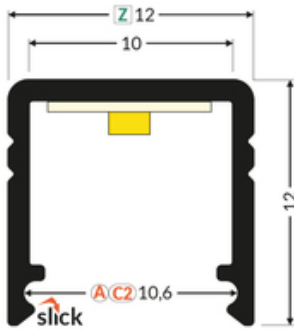

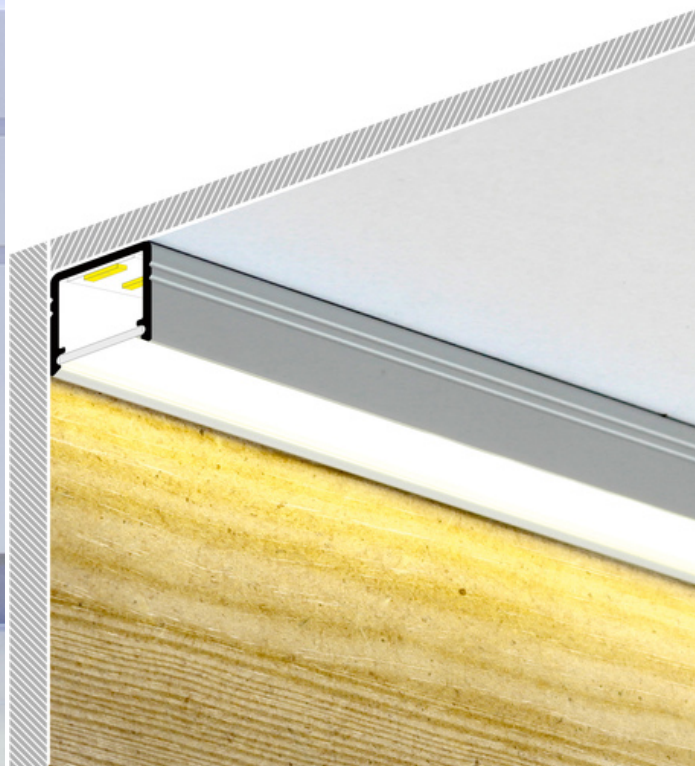

Basic Informations

Material: aluminium
Color: black anodized
Length [mm]: 2000
Country of origin: PL

AVAILABLE VARIANTS

Matching elements

DIFFUSERS

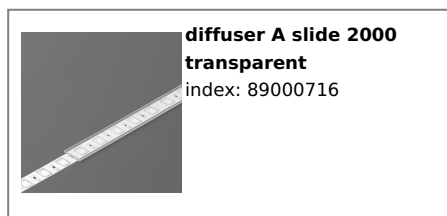
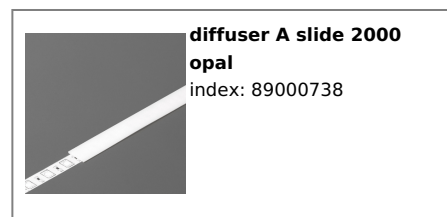
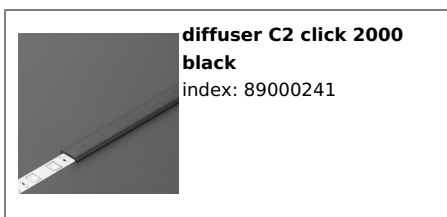
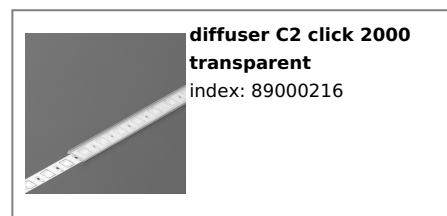
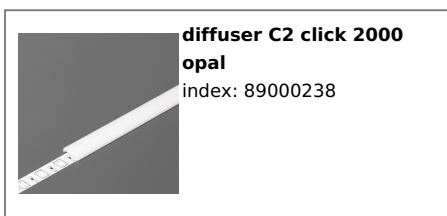

END CAPS



CONNECTORS



connector SMART10
90deg black anod.
/plastic bag
index: C2910021

MOUNTING PLATES



mounting plate Z cone
black [20pcs]
index: 89980002



mounting plate Z black
[20pcs]
index: 89270002