

LED PROFILE SURFACE10 BC/UX 1000 ANOD.







Surface



Furniture



max 10 mm

	<ul style="list-style-type: none"> • hidden mounting • wide range of accessories, 7 types of diffusers 	 EU industrial designs  CE  Made in Poland	 Buy product
-----------------------------------------------------------------------------------	--------------------------------------------------------------------------------------------------------------------------------	-----------------------------------------------------------------------------------------------------------------------------------------------------------------------------------------------------------------------------------------------------------------------------------------------------	----------------------------------------------------------------------------------------------------

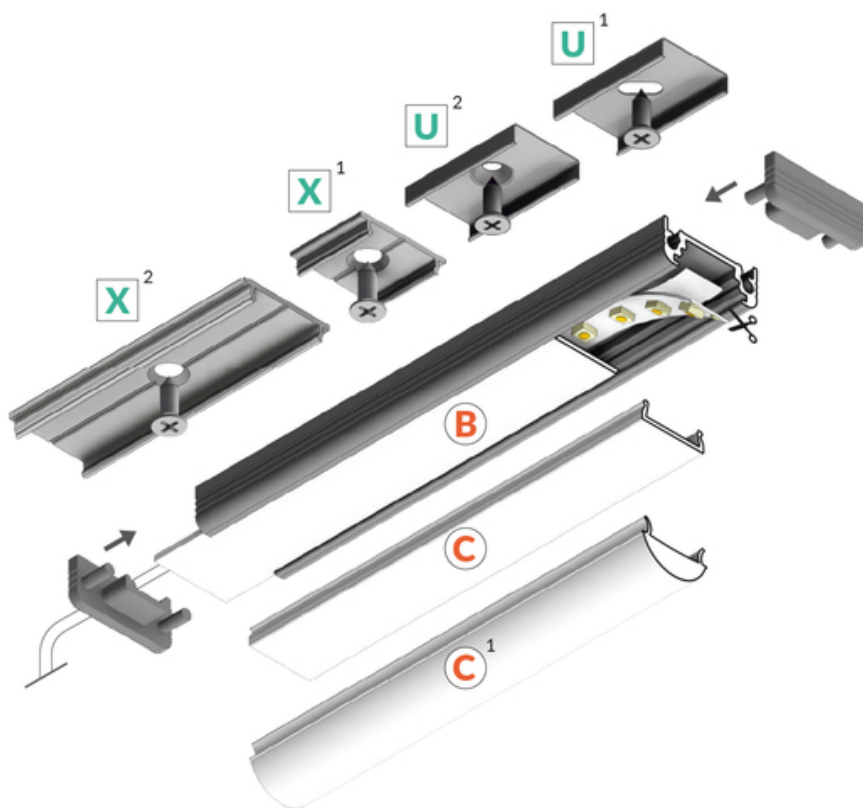
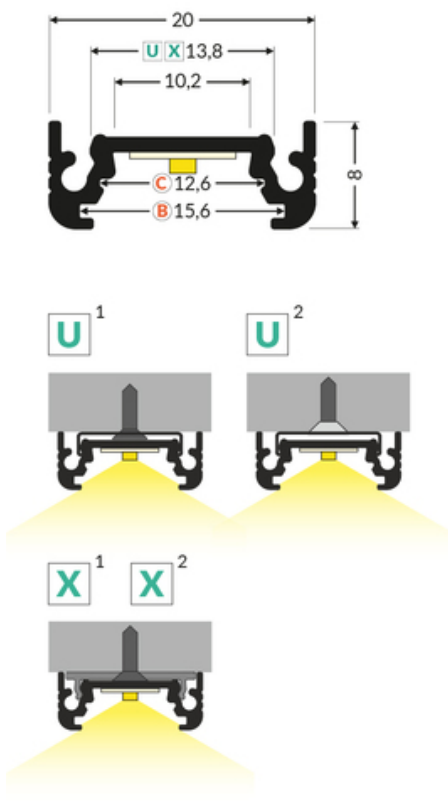

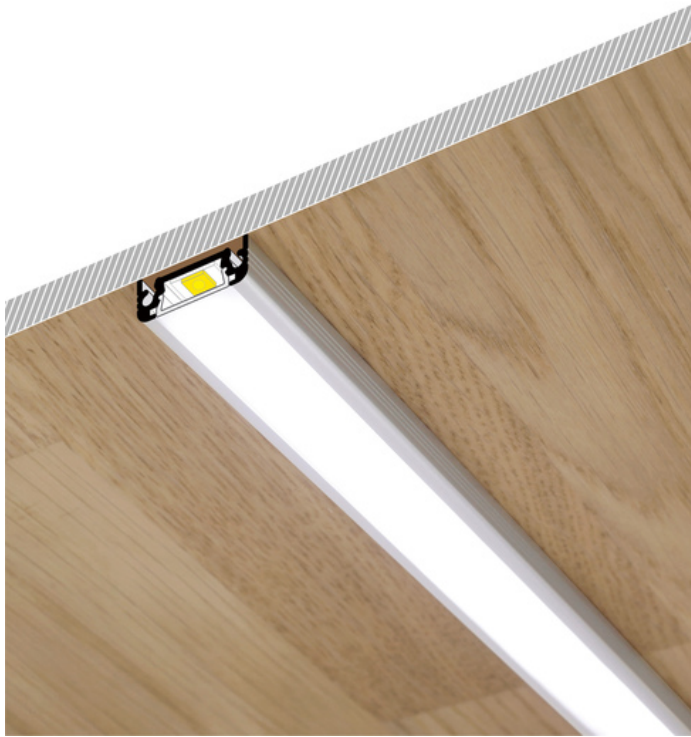

Basic Informations

<p>EAN: 5901597201151 Index: 77260020 Material: aluminium Color: anodized Length [mm]: 1000 Weight [kg]: 0.129 Net weight [kg]: 0.018 Country of origin: PL</p>	<p>Measurement unit: qty Product packaging dimensions [mm]: 1000 x 20 x 8 Bulk packing [qty]: 40 Master packaging type: Bulk Product with gross packaging weight [kg]: 5.16</p>
---------------------------------------------------------------------------------------------------------------------------------------------------------------------------------------------	-------------------------------------------------------------------------------------------------------------------------------------------------------------------------------------------------

AVAILABLE COLORS

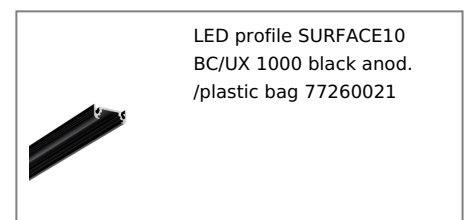
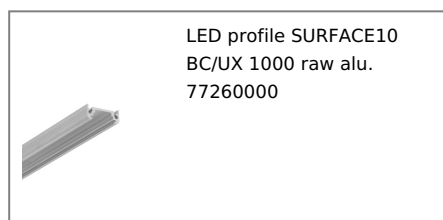
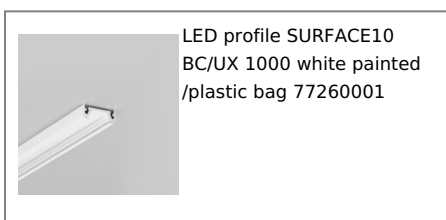

AVAILABLE VARIANTS

1000 mm, 2000 mm, 3000 mm, 4050 mm

Matching elements

DIFFUSERS

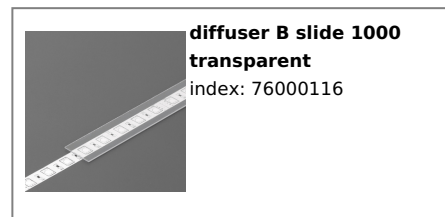
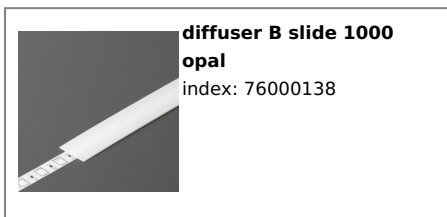
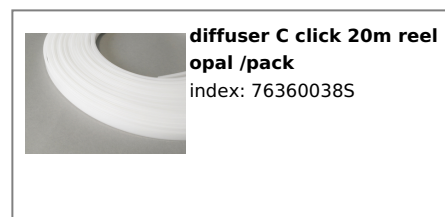

MOUNTINGS

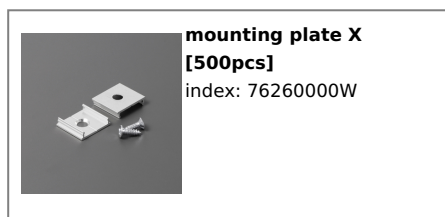
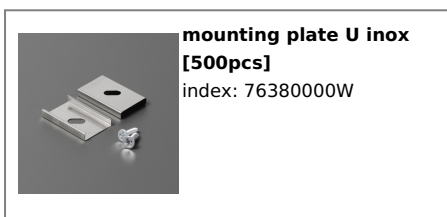

END CAPS





**end cap SURFACE10
gen2 silver [20pcs]**
index: 77990040



**end cap SURFACE10
gen2 with hole grey
[20pcs]**
index: 77980022



**end cap SURFACE10
gen2 with hole silver
[20pcs]**
index: 77980040

CONNECTORS



**connector SURFACE10
90deg anod. /plastic bag**
index: 77410020



**connector X 180deg
/plastic bag [1pc]**
index: 76350000



**connector X 180deg
/plastic bag [200pc]**
index: 76350000W