

LED PROFILE SURFACE10 BC/UX 2000 BLACK ANOD. [40PCS]

x40
pcs.

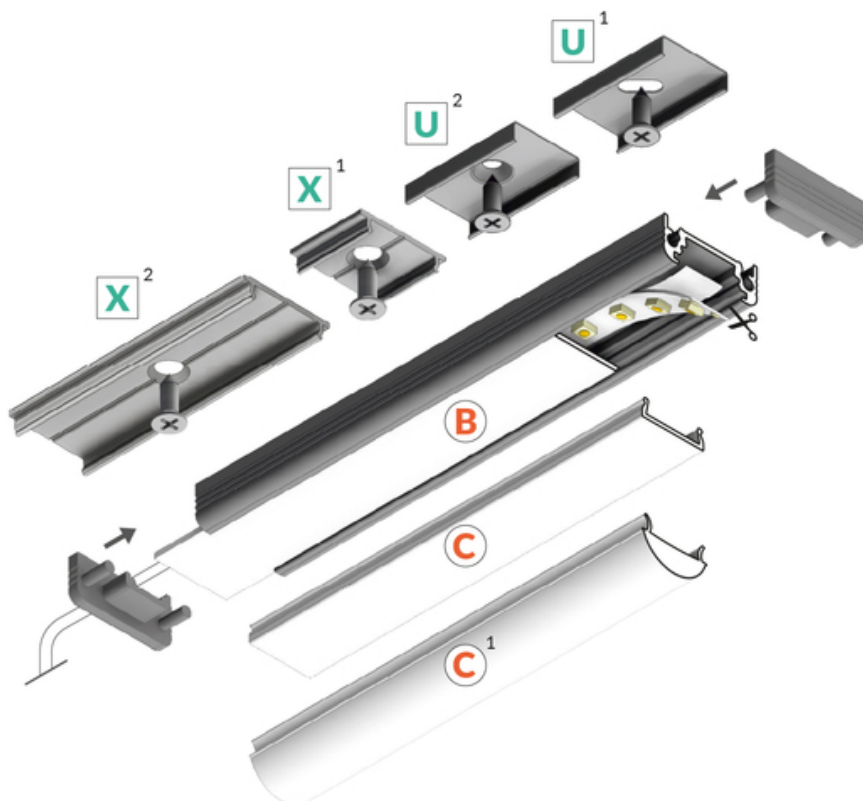

Buy product

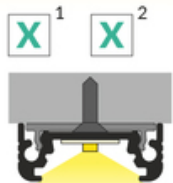
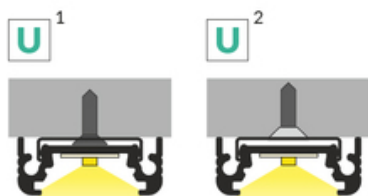
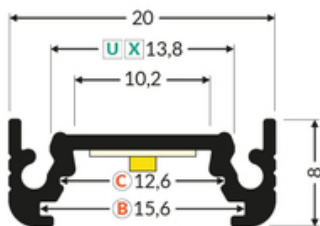

TOPMET LIGHT KŁOSOWICZ WIŚNIEWSKI sp. z o.o.

Ostrowska 354 | 61-312 Poznań | POLAND

tel.: +48 61 872 75 00

info@topmet.pl

pdf card generation date: 10.03.2025



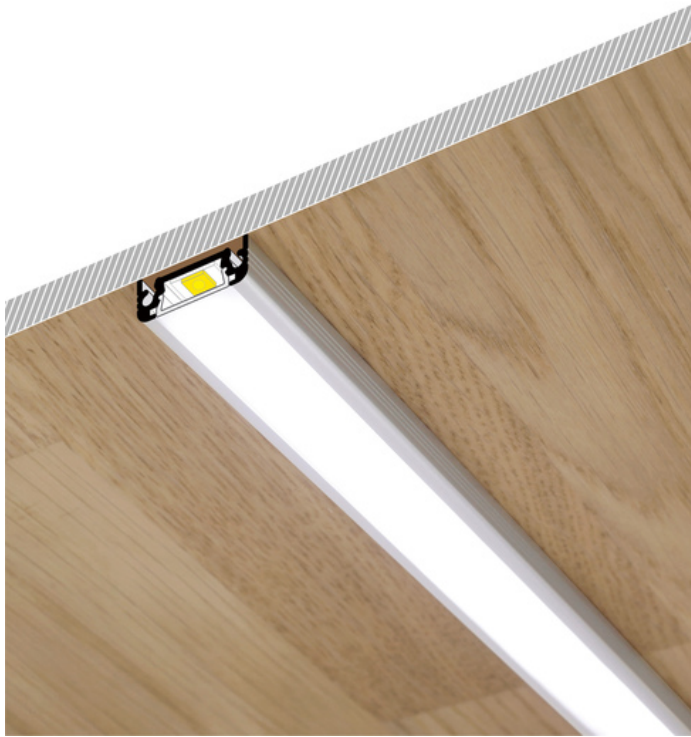

Basic Informations

Material: aluminium
Color: black anodized
Length [mm]: 2000
Country of origin: PL

AVAILABLE VARIANTS

Matching elements

DIFFUSERS

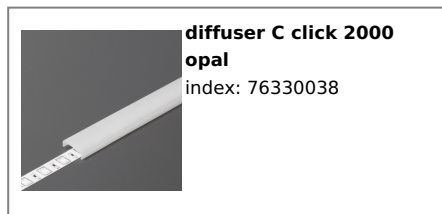
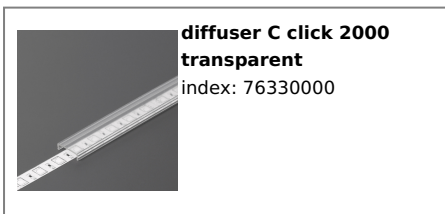

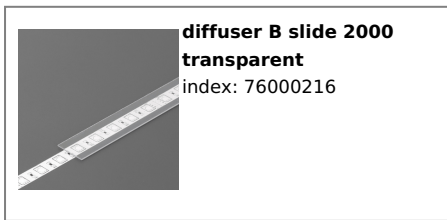
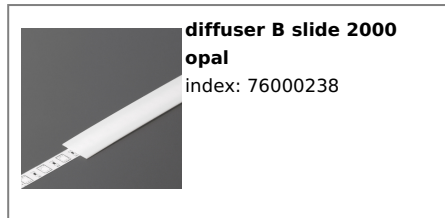

MOUNTINGS

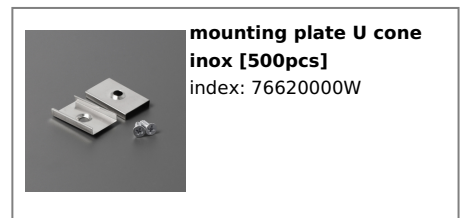
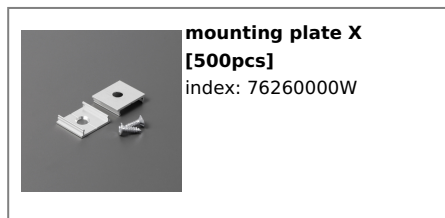

END CAPS



CONNECTORS

TOPMET LIGHT KŁOSOWICZ WIŚNIEWSKI sp. z o.o.

Ostrowska 354 | 61-312 Poznań | POLAND

tel.: +48 61 872 75 00

info@topmet.pl

pdf card generation date: 10.03.2025



connector SURFACE10
90deg black anod.
/plastic bag
index: 77410021



connector X 180deg
/plastic bag [200pc]
index: 76350000W

MOUNTING PLATES



mounting plate X spring
/plastic bag [1pcs]
index: 23130000