

LED PROFILE SURFACE14 EE7F/TY 2000 BLACK ANOD.

/PLASTIC BAG







Surface



Furniture



max 14 mm

	<ul style="list-style-type: none">• hidden mounting• many system accessories available	 CE  EU industrial designs  Made in Poland	 Buy product
---	---	---	--

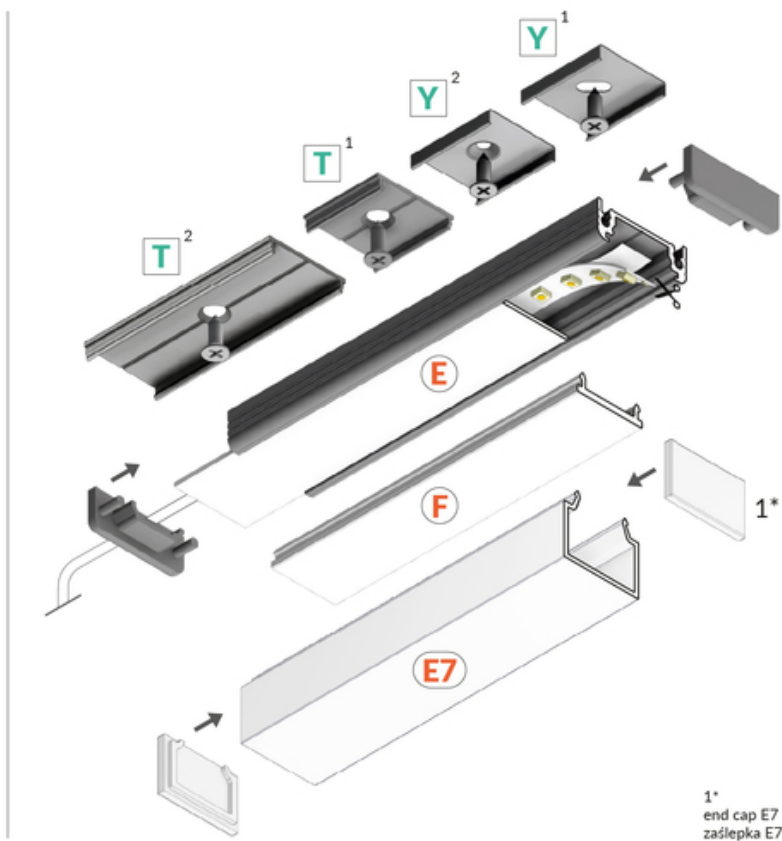
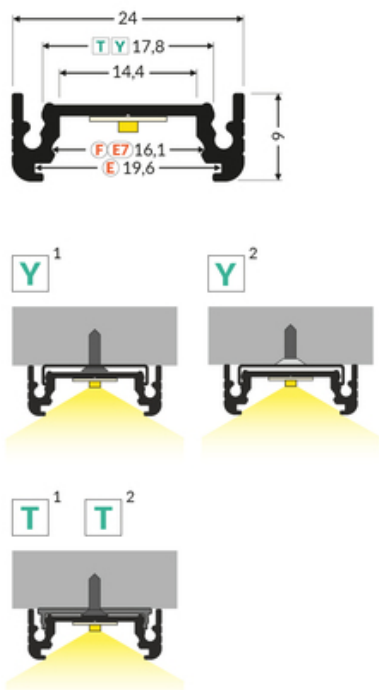

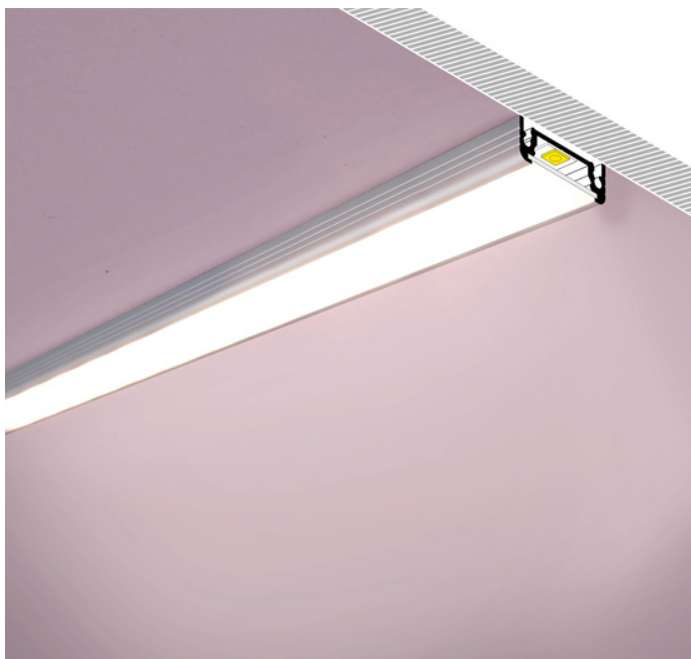

Basic Informations

EAN: 5901597204862

Index: A2020021

Material: aluminium

Color: black anodized

Length [mm]: 2000

Weight [kg]: 0.338

Net weight [kg]: 0.006

Country of origin: PL

Measurement unit: qty

Product packaging dimensions [mm]: 2000 x 24 x 9

Bulk packing [qty]: 40

Master packaging type: Carton

Product with gross packaging weight [kg]: 14.58

AVAILABLE COLORS

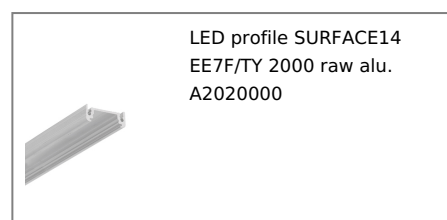
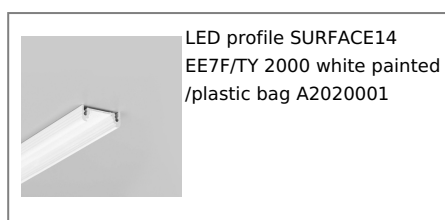
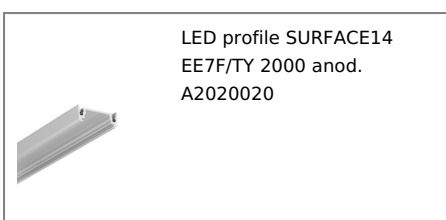

AVAILABLE VARIANTS

1000 mm, 2000 mm, 3000 mm, 4050 mm

Matching elements

TOPMET LIGHT KŁOSOWICZ WIŚNIEWSKI sp. z o.o.

Ostrowska 354 | 61-312 Poznań | POLAND

tel.: +48 61 872 75 00

info@topmet.pl

pdf card generation date: 10.03.2025

DIFFUSERS

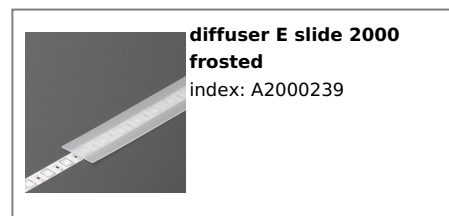
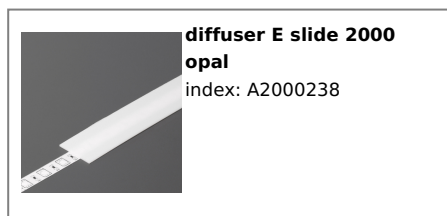

MOUNTINGS

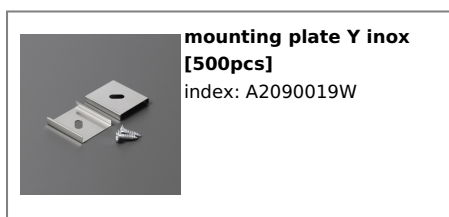

END CAPS

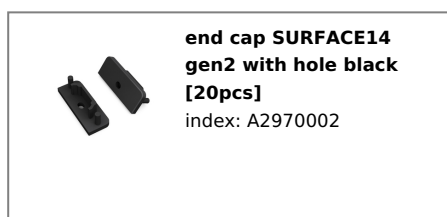

TOPMET LIGHT KŁOSOWICZ WIŚNIEWSKI sp. z o.o.

Ostrowska 354 | 61-312 Poznań | POLAND

tel.: +48 61 872 75 00

info@topmet.pl

pdf card generation date: 10.03.2025

CONNECTORS



connector SURFACE14
90deg black anod.
/plastic bag
index: A2990021



connector T 180deg
/plastic bag
index: C6990000



connector T 180deg
/plastic bag [200pcs]
index: C6990000W
