

LED PROFILE DIAGONAL14 F/TY 2000 ANOD.



Furniture







max 14 mm



Corner



Recessed

	<ul style="list-style-type: none"> • reduced glare effect • used mainly in furniture 	<p>  CE  EU industrial designs  Made in Poland </p>	 <p>Buy product</p>
---	--	--	--

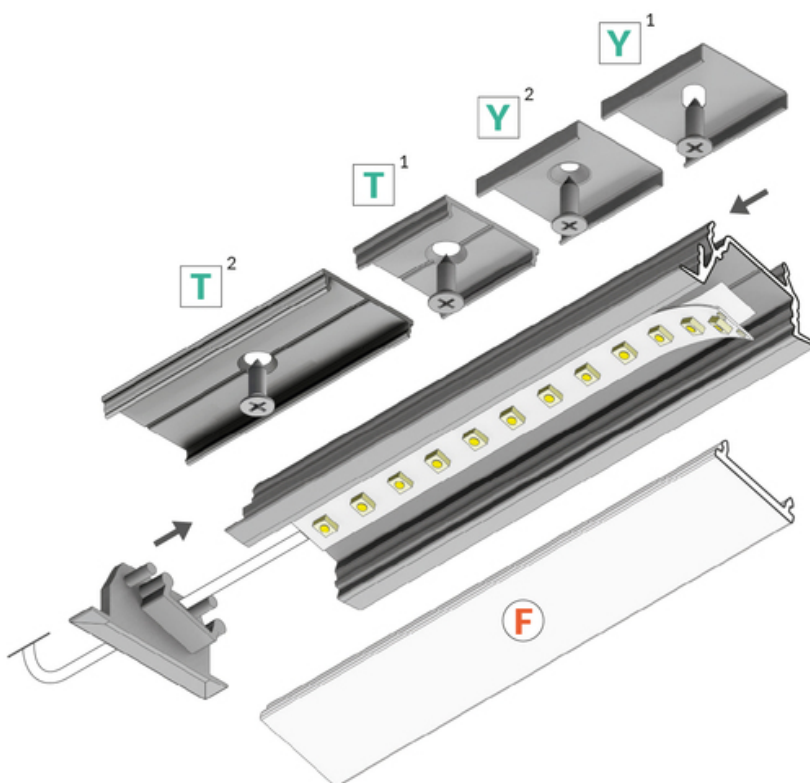
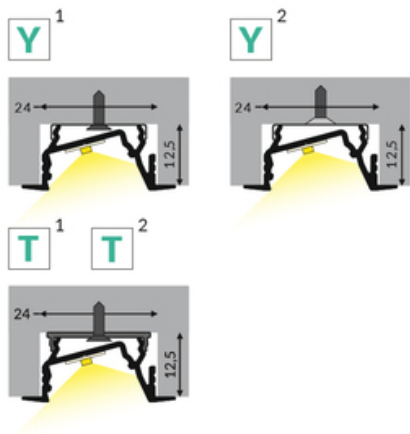
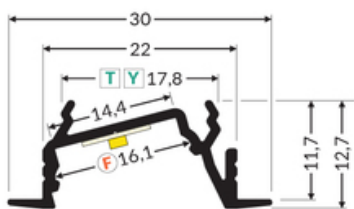

TOPMET LIGHT KŁOSOWICZ WIŚNIEWSKI sp. z o.o.

Ostrowska 354 | 61-312 Poznań | POLAND

tel.: +48 61 872 75 00

info@topmet.pl

pdf card generation date: 10.03.2025





Basic Informations

EAN: 5901597284154
Index: H5020020
Material: aluminium
Color: anodized
Length [mm]: 2000
Weight [kg]: 0.306
Net weight [kg]: 0.015
Country of origin: PL

Measurement unit: qty
Product packaging dimensions [mm]: 2000 x 30 x 12,7
Bulk packing [qty]: 40
Master packaging type: Bulk
Product with gross packaging weight [kg]: 12.24

AVAILABLE COLORS

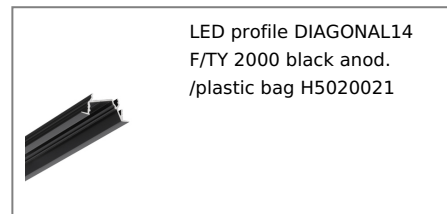
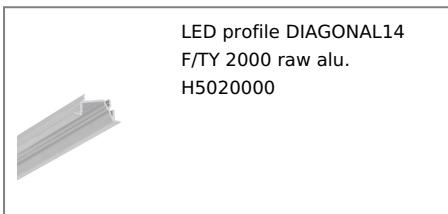

AVAILABLE VARIANTS

1000 mm, 2000 mm, 3000 mm, 4050 mm

Matching elements

DIFFUSERS

TOPMET LIGHT KŁOSOWICZ WIŚNIEWSKI sp. z o.o.
Ostrowska 354 | 61-312 Poznań | POLAND
tel.: +48 61 872 75 00
info@topmet.pl

pdf card generation date: 10.03.2025



MOUNTINGS

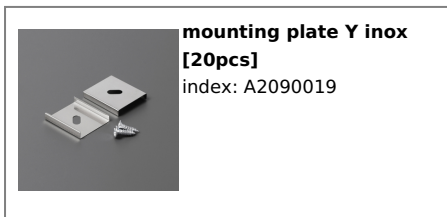
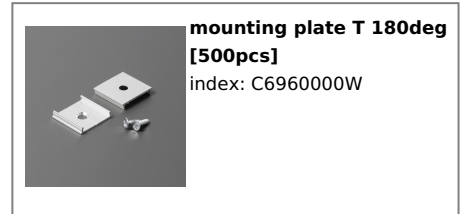
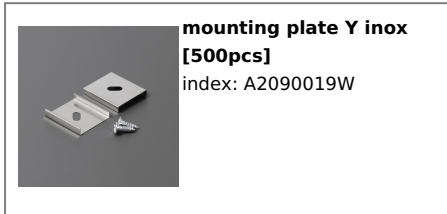

END CAPS

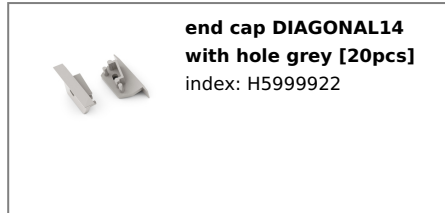
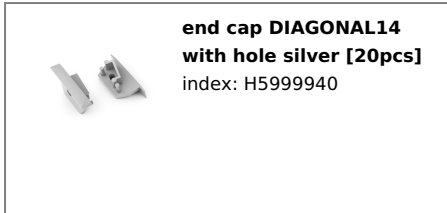

CONNECTORS

