

LED PROFILE GROOVE10.V2 A1C/U 2000 ANOD.







Recessed



Furniture



max 10 mm

	<ul style="list-style-type: none"> • a new generation of recessed profiles • basic and aesthetically pleasing furniture profile • shallow mounting hole depth 	 CE  EU industrial designs  Made in Poland	 Buy product
---	--	---	--

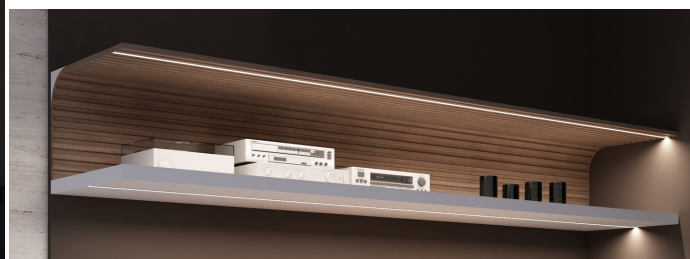
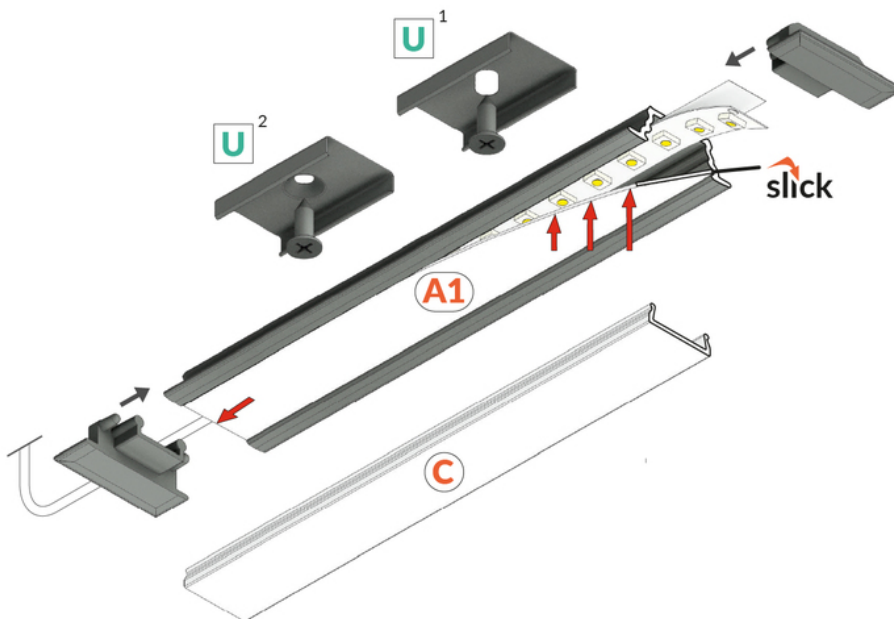
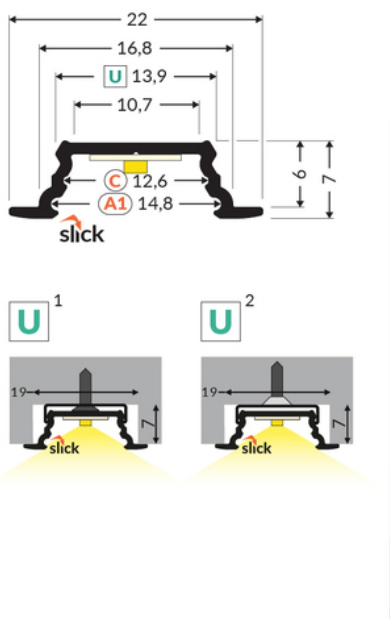

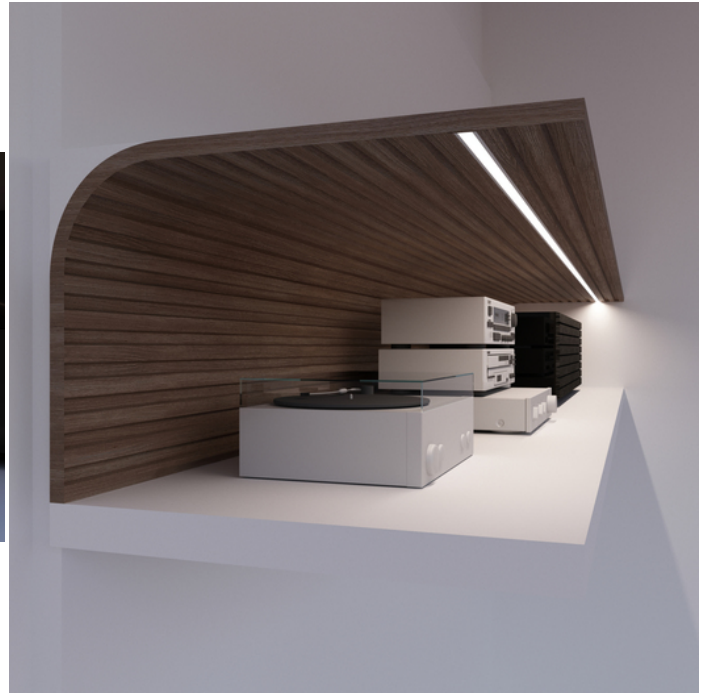

Basic Informations

EAN: 5901597231479 Index: K5000220 Material: aluminium Color: anodized Length [mm]: 2000 Weight [kg]: 0.178 Net weight [kg]: 0.024 Country of origin: PL	Measurement unit: qty Product packaging dimensions [mm]: 2000 x 22 x 7 Bulk packing [qty]: 40 Master packaging type: Bulk Product with gross packaging weight [kg]: 7.12
---	--

AVAILABLE COLORS

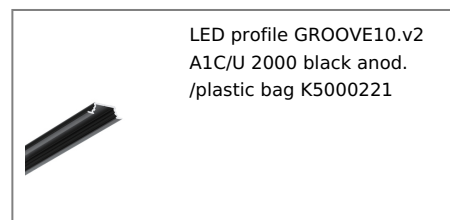
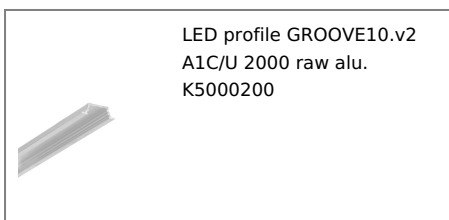

AVAILABLE VARIANTS

2000 mm, 4050 mm

Matching elements

DIFFUSERS

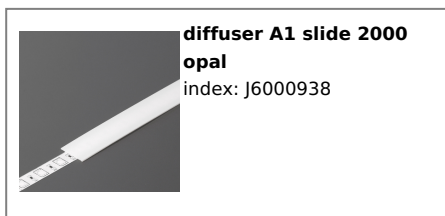
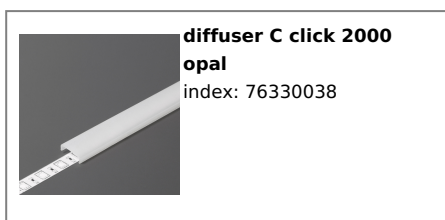
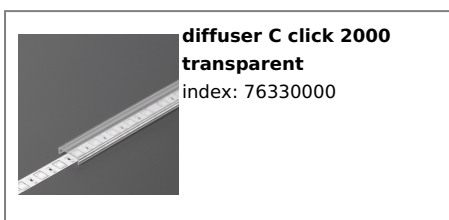

TOPMET LIGHT KŁOSOWICZ WIŚNIEWSKI sp. z o.o.

Ostrowska 354 | 61-312 Poznań | POLAND

tel.: +48 61 872 75 00

info@topmet.pl

pdf card generation date: 10.03.2025



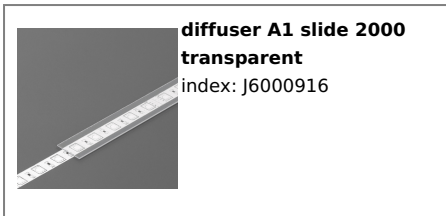

MOUNTINGS



END CAPS

