

# LED PROFILE GROOVE14 EE7F/TY 1000 ANOD.







Recessed



Furniture



max 14 mm

	<ul style="list-style-type: none"> <li>• used mainly in furniture</li> <li>• many accessories available</li> </ul>	 EU industrial designs  CE  Made in Poland	 Buy product
---	--	---	--

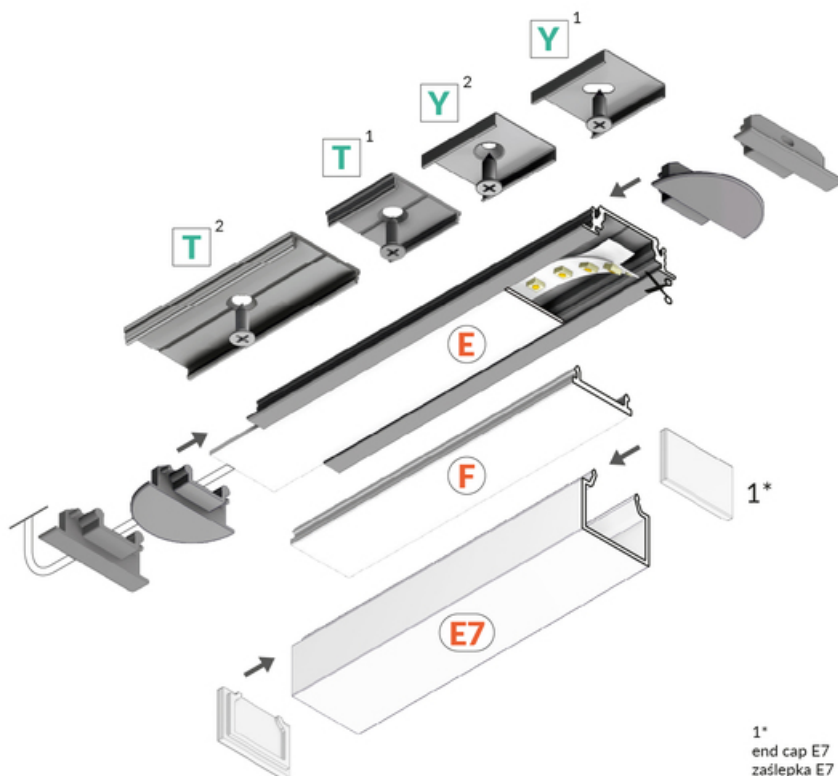
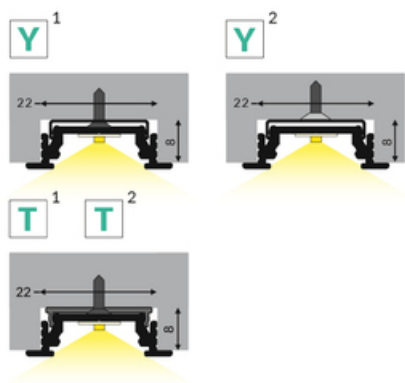
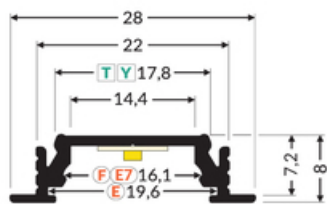



1\*  
end cap E7  
zaślepka E7



## Basic Informations

<p>EAN: 5901597205036          Index: A3010020          Material: aluminium          Color: anodized          Length [mm]: 1000          Weight [kg]: 0.149          Net weight [kg]: 0.006          Country of origin: PL</p>	<p>Measurement unit: qty          Product packaging dimensions [mm]: 1000 x 28 x 8          Bulk packing [qty]: 40          Master packaging type: Bulk          Product with gross packaging weight [kg]: 5.96</p>
--	---

## AVAILABLE COLORS

 <p>LED profile GROOVE14          EE7F/TY 1000 white painted          /plastic bag A3010001</p>	 <p>LED profile GROOVE14          EE7F/TY 1000 raw al.          A3010000</p>	 <p>LED profile GROOVE14          EE7F/TY 1000 black anod.          /plastic bag A3010021</p>
--	---	--

## AVAILABLE VARIANTS

1000 mm, 2000 mm, 3000 mm, 4050 mm

## Matching elements

## DIFFUSERS

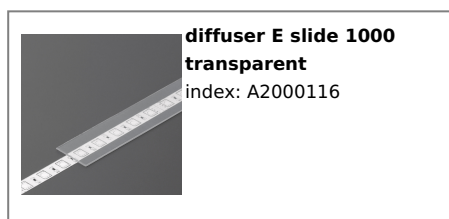

## MOUNTINGS



## END CAPS

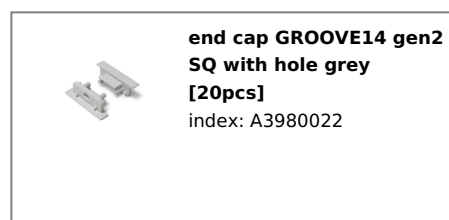
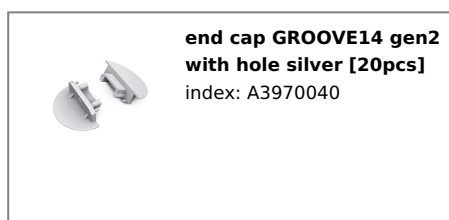
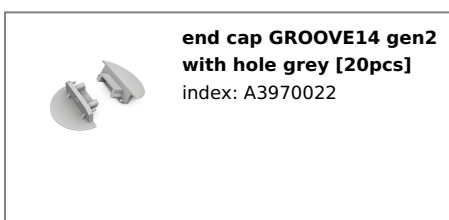

TOPMET LIGHT KŁOSOWICZ WIŚNIEWSKI sp. z o.o.

Ostrowska 354 | 61-312 Poznań | POLAND

tel.: +48 61 872 75 00

info@topmet.pl

pdf card generation date: 10.03.2025



**end cap GROOVE14 gen2  
SQ with hole silver**  
[20pcs]  
index: A3980040

---

## CONNECTORS



**connector GROOVE14  
90deg anod. /plastic bag**  
index: A3990020



**connector T 180deg  
/plastic bag**  
index: C6990000



**connector T 180deg  
/plastic bag [200pcs]**  
index: C6990000W