

LED PROFILE LINEA-IN20 EE7F/U7 2000 ANOD.



Recessed



Architectural



- continuous line of light (when using LED strip 120 P/m and opal diffuser)
- angled connections illuminated
- over 20 accessories available

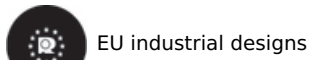

EU industrial designs



CE

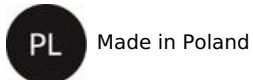

Made in Poland



Buy product

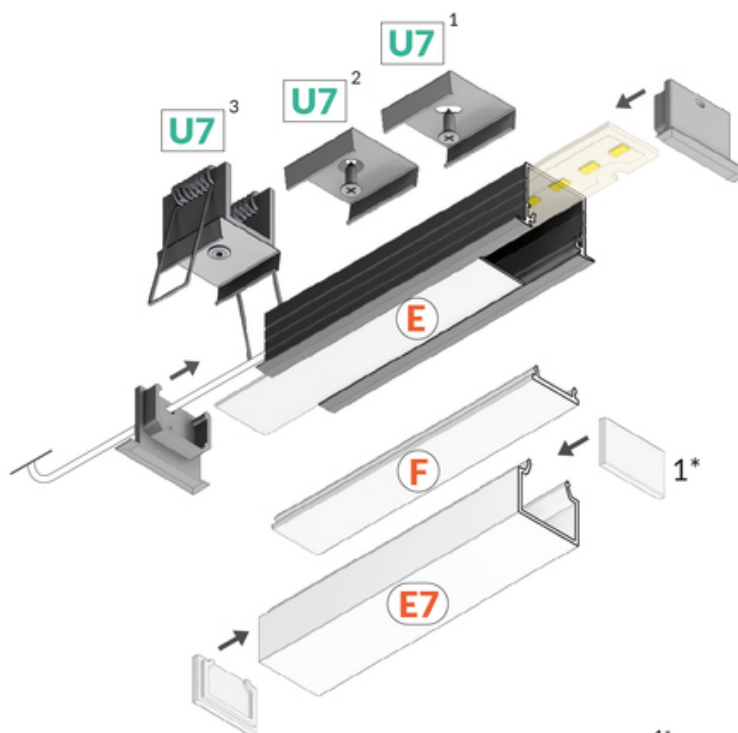
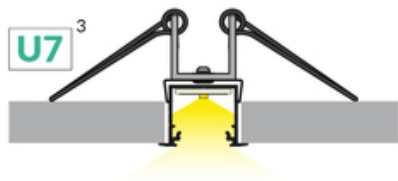
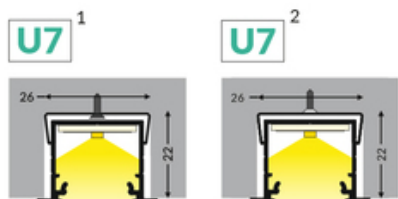
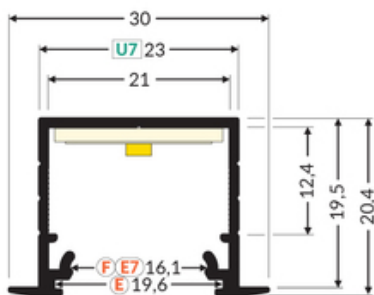

1*
end cap E7
zaślepka E7

TOPMET LIGHT KŁOSOWICZ WIŚNIEWSKI sp. z o.o.

Ostrowska 354 | 61-312 Poznań | POLAND

tel.: +48 61 872 75 00

info@topmet.pl

pdf card generation date: 08.03.2025



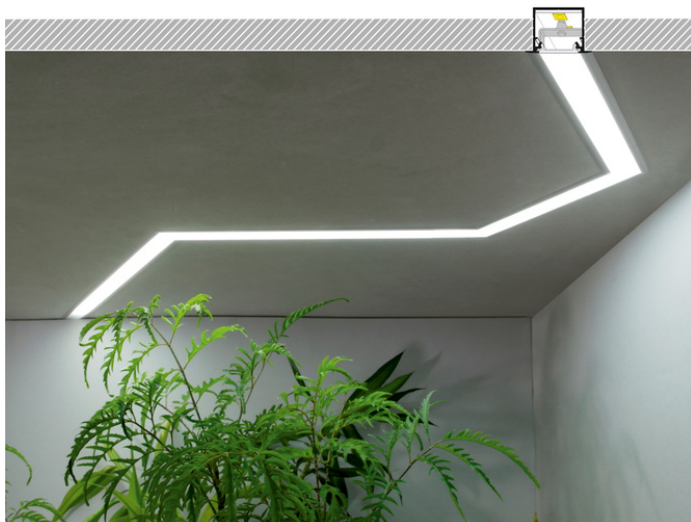

Basic Informations

EAN: 5901597237273

Index: E4020020

Material: aluminium

Color: anodized

Length [mm]: 2000

Weight [kg]: 0.436

Country of origin: PL

Measurement unit: qty

Product packaging dimensions [mm]: 2000 x 30 x 20,4

Bulk packing [qty]: 20

Master packaging type: Bulk

Product with gross packaging weight [kg]: 8.72

AVAILABLE COLORS

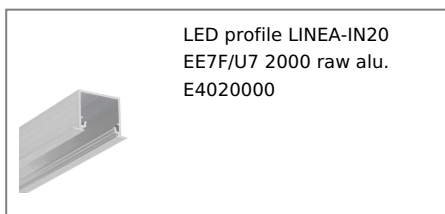

AVAILABLE VARIANTS

1000 mm, 2000 mm, 3000 mm, 4050 mm

Matching elements

DIFFUSERS

TOPMET LIGHT KŁOSOWICZ WIŚNIEWSKI sp. z o.o.

Ostrowska 354 | 61-312 Poznań | POLAND

tel.: +48 61 872 75 00

info@topmet.pl

pdf card generation date: 08.03.2025

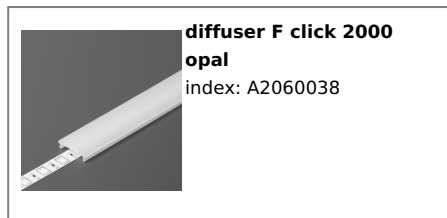

END CAPS

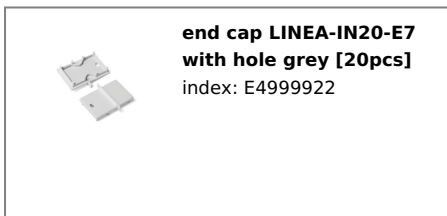
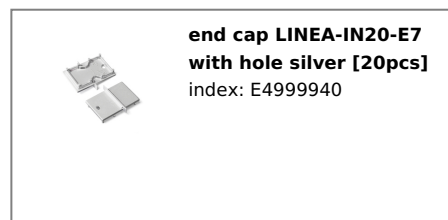
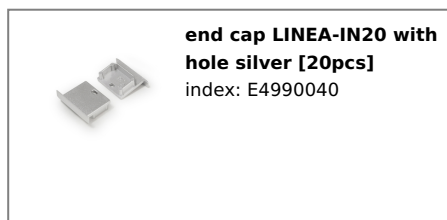

CONNECTORS

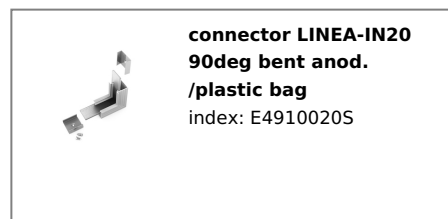
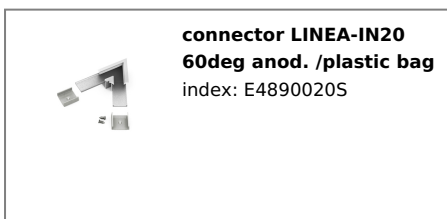



**connector LINEA-IN20
120deg anod. /plastic
bag**
index: E4920020S



**connector LINEA-IN20
135deg anod. /plastic
bag**
index: E4930020S



**connector LINEA-IN20
180deg /plastic bag**
index: E4940000s



**connector LINEA-IN20
270deg bent anod.
/plastic bag**
index: E4950020S

OTHER



**LED clamp LINEA20
white painted [20pcs]**
index: C6940001



**LINEA20-1 LED clamp
white [20pcs]**
index: C6930001