

LED PROFILE CORNER10 BC/UX 1000 WHITE PAINTED /PLASTIC BAG



Furniture



max 10 mm



Corner



- lighting directions: 30° or 60°
- hidden mounting

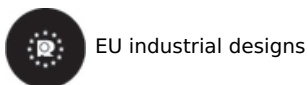

EU industrial designs



CE

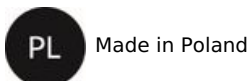

Made in Poland



Buy product

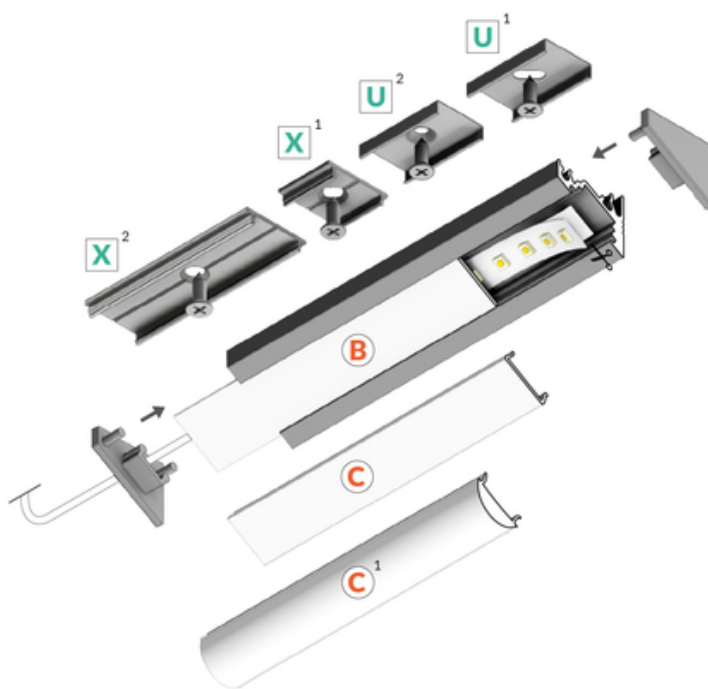
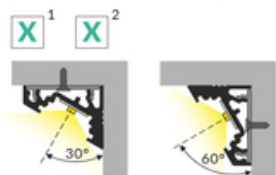
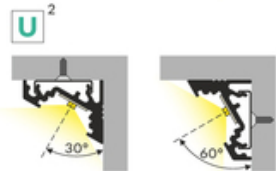
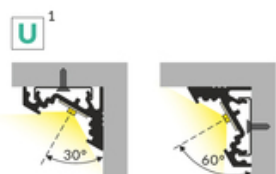
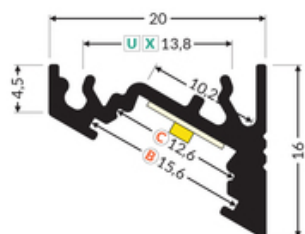

TOPMET LIGHT KŁOSOWICZ WIŚNIEWSKI sp. z o.o.

Ostrowska 354 | 61-312 Poznań | POLAND

tel.: +48 61 872 75 00

info@topmet.pl

pdf card generation date: 10.03.2025



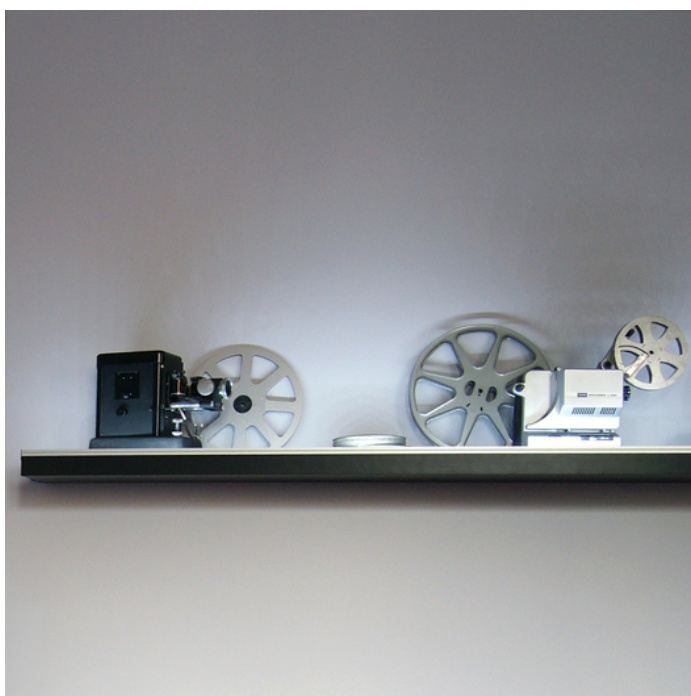



Basic Informations

<p>EAN: 5901597203483 Index: 83040001 Material: aluminium Color: white painted Length [mm]: 1000 Weight [kg]: 0.216 Net weight [kg]: 0.006000000000000001 Country of origin: PL</p>	<p>Measurement unit: qty Product packaging dimensions [mm]: 1000 x 20 x 16 Bulk packing [qty]: 40 Master packaging type: Carton Product with gross packaging weight [kg]: 9.05</p>
---	--

AVAILABLE COLORS





 <p>LED profile CORNER10 BC/UX 1000 raw alu. 83040000</p>	 <p>LED profile CORNER10 BC/UX 1000 anod. 83040020</p>	 <p>LED profile CORNER10 BC/UX 1000 black anod. /plastic bag 83040021</p>
--	---	--

AVAILABLE VARIANTS

1000 mm, 2000 mm, 3000mm, 4050 mm

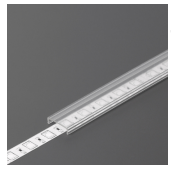
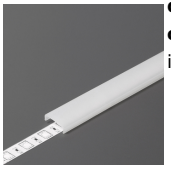
Matching elements

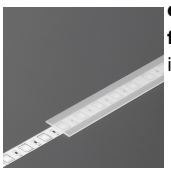
DIFFUSERS

 <p>diffuser C click 1000 transparent index: 76320000</p>	 <p>diffuser C click 1000 opal index: 76320038</p>	 <p>diffuser C click 20m reel opal /pack index: 76360038S</p>
 <p>diffuser B slide 1000 opal index: 76000138</p>	 <p>diffuser B slide 1000 frosted index: 76000139</p>	 <p>diffuser B slide 1000 transparent index: 76000116</p>

MOUNTINGS

 <p>mounting plate U inox [500pcs] index: 76380000W</p>	 <p>mounting plate X [500pcs] index: 76260000W</p>	 <p>mounting plate U cone inox [500pcs] index: 76620000W</p>
 <p>mounting plate U cone inox [20pcs] index: 76620000</p>	 <p>mounting plate U inox [20pcs] index: 76380000</p>	 <p>mounting plate X [20pcs] index: 76260000</p>

END CAPS

 <p>(EOL) end cap CORNER10 white [20pcs] index: 83150001</p>	 <p>end cap CORNER10 gen2 white [20pcs] index: 83990001</p>	 <p>end cap CORNER10 gen2 with hole white [20pcs] index: 83980001</p>
--	---	---

CONNECTORS

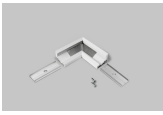
 <p>connector CORNER10 90deg white painted /plastic bag index: 83110001</p>	 <p>connector X 180deg /plastic bag [1pc] index: 76350000</p>	 <p>connector X 180deg /plastic bag [200pc] index: 76350000W</p>
---	---	--