

# LED PROFILE CORNER10 BC/UX 2000 BLACK ANOD. /PLASTIC

## BAG







Corner



Furniture



max 10 mm

	<ul style="list-style-type: none"> <li>lighting directions: 30° or 60°</li> <li>hidden mounting</li> </ul>	 CE  EU industrial designs  Made in Poland	 Buy product
---	--	---	--

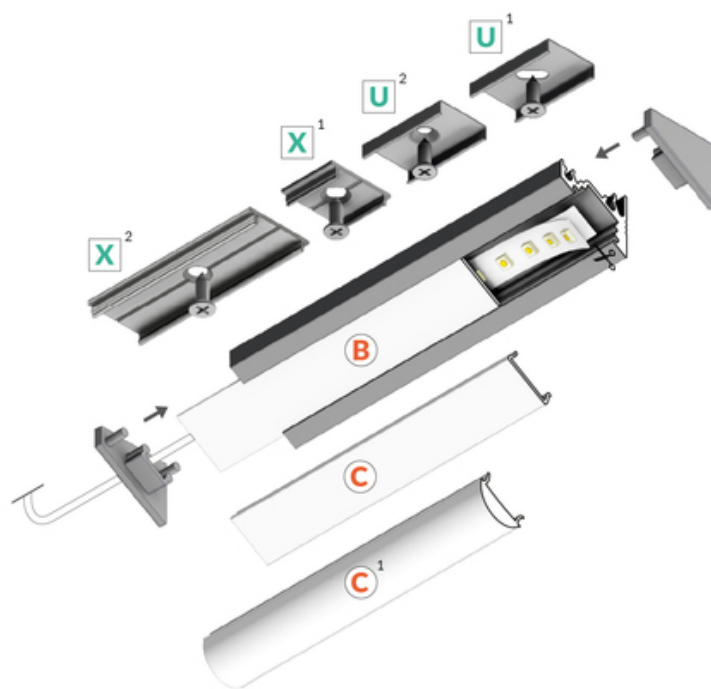
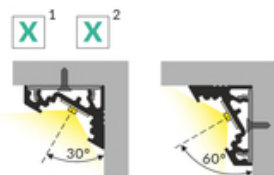
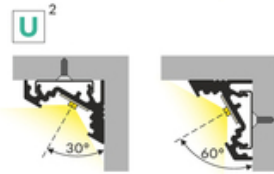
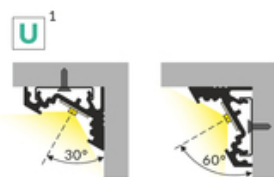
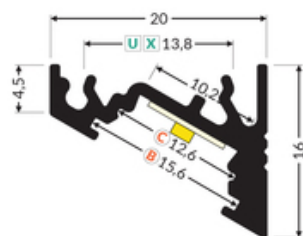

TOPMET LIGHT KŁOSOWICZ WIŚNIEWSKI sp. z o.o.

Ostrowska 354 | 61-312 Poznań | POLAND

tel.: +48 61 872 75 00

info@topmet.pl

pdf card generation date: 10.03.2025



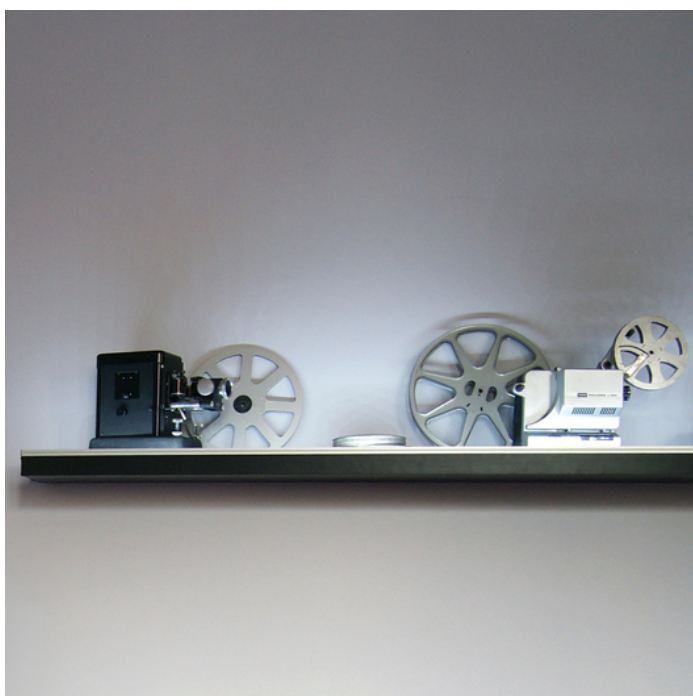



## Basic Informations

<p>EAN: 5901597203513 Index: 83050021 Material: aluminium Color: black anodized Length [mm]: 2000 Weight [kg]: 0.4 Net weight [kg]: 0.012 Country of origin: PL</p>	<p>Measurement unit: qty Product packaging dimensions [mm]: 2000 x 20 x 16 Bulk packing [qty]: 40 Master packaging type: Carton Product with gross packaging weight [kg]: 17.06</p>
---	---

## AVAILABLE COLORS





 <p>LED profile CORNER10 BC/UX 2000 white painted /plastic bag 83050001</p>	 <p>LED profile CORNER10 BC/UX 2000 raw alu. 83050000</p>	 <p>LED profile CORNER10 BC/UX 2000 anod. 83050020</p>
--	--	---

## AVAILABLE VARIANTS

1000 mm, 2000 mm, 3000 mm, 4050 mm

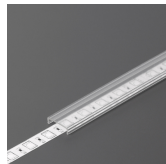
## Matching elements

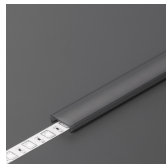
## DIFFUSERS

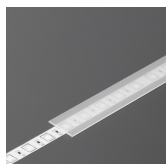
 <p><b>diffuser C click 2000 transparent</b> index: 76330000</p>	 <p><b>diffuser C click 2000 opal</b> index: 76330038</p>	 <p><b>diffuser C click 2000 black</b> index: 76330041</p>
 <p><b>diffuser C click 20m reel opal /pack</b> index: 763600385</p>	 <p><b>diffuser B slide 2000 opal</b> index: 76000238</p>	 <p><b>diffuser B slide 2000 frosted</b> index: 76000239</p>

TOPMET LIGHT KŁOSOWICZ WIŚNIEWSKI sp. z o.o.

Ostrowska 354 | 61-312 Poznań | POLAND

tel.: +48 61 872 75 00

info@topmet.pl

pdf card generation date: 10.03.2025

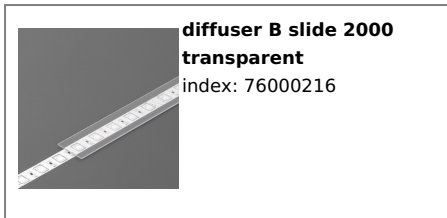

## MOUNTINGS

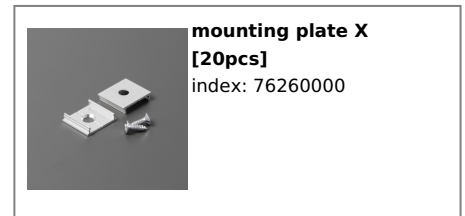
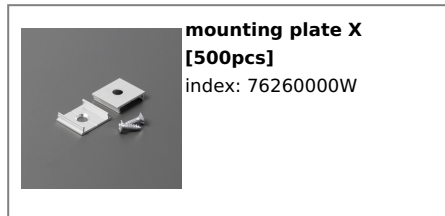

## END CAPS

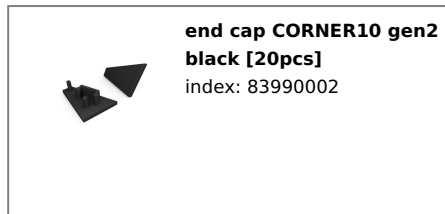

## CONNECTORS

